



# Underscore® Rectangle

60" x 30" alcove bath

K-1121-L

## Features

- Integral lumbar support.
- Slotted overflow allows for deep soaking.
- Integral flange helps prevent water from seeping behind wall and simplifies alcove installation.

## Material

- Acrylic.
- Acrylic.

## Installation

- Requires K-7271 or K-7272 Clearflo slotted overflow bath drain (sold separately).
- Left drain.
- Alcove.

## Required Products/Accessories

K-7271 Brass Slotted Overflow Bath Drain

or

K-7272 PVC Slotted Overflow Bath Drain

## Recommended Products/Accessories

K-1491 Bath/Whirlpool Pillow

K-1601 Bath/whirlpool footstop, removable

K-24916 Wireless Music Kit

K-23726 Drain treatment

K-23732 Tub & shower cleaner



ADA

## Codes/Standards

CSA B45.5/IAPMO Z124

ASTM E162

ASTM E662

ADA









ICC/ANSI A117.1

## KOHLER® Plastic Baths and Receptors Lifetime Limited Warranty

See website for detailed warranty information.

## Available Colors/Finishes

*Color tiles intended for reference only.*

Color	Code	Description
	0	White
	96	Biscuit
	NY	Dune
	95	Ice™ Grey
	G9	Sandbar
	K4	Cashmere
	58	Thunder™ Grey
	7	Black Black™

1-800-4KOHLER (1-800-456-4537)

Kohler Co. reserves the right to make revisions without notice to product specifications.

For the most current Specification Sheet, go to [www.kohler.com](http://www.kohler.com).

5-29-2021 13:51 - US/CA

THE BOLD LOOK  
OF **KOHLER**®

No change in measurement if connected with drain illustrated. (K-7272)

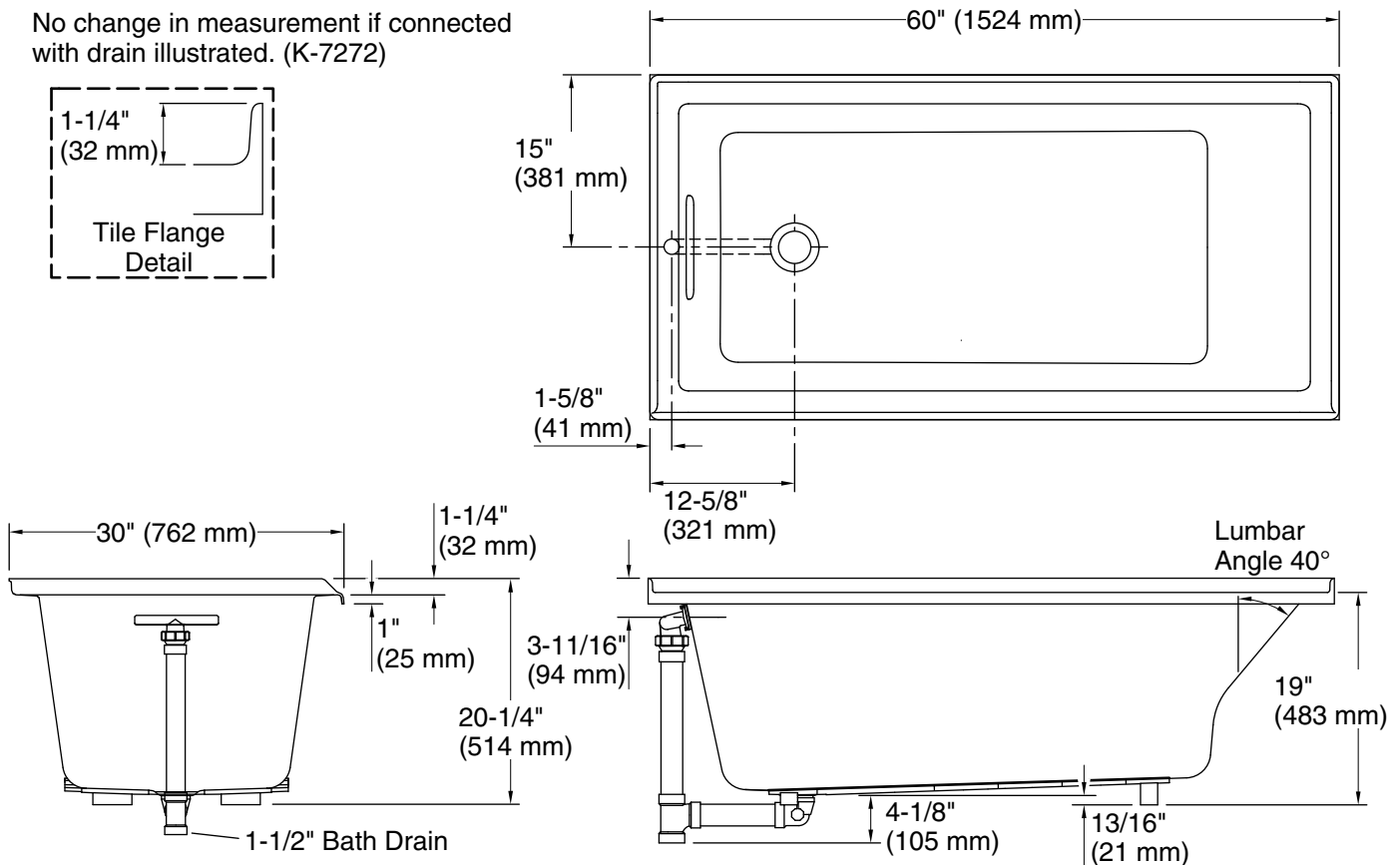
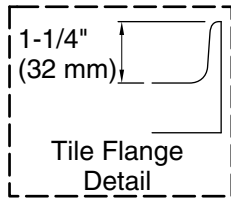

### Technical Information

All product dimensions are nominal.

Installation:	Three-wall alcove
Drain location:	Left
Basin area, bottom:	42-7/16" x 20" (1078 mm x 508 mm)
Basin area, top:	54-5/16" x 24-1/4" (1380 mm x 616 mm)
Weight:	75 lbs (34 kg)
Minimum floor load:	42 lbs/ft <sup>2</sup> (205.1 kg/m <sup>2</sup> )
Water depth:	15-1/8" (384 mm)
Water capacity:	59.8 gal (226.4 L)
Minimum flat for door:	1-15/16" (50 mm)

### Notes

Measure your actual product for rough-in details.

Install this product according to the installation instructions.

The hot water supply should be 70% of the capacity of the bath or greater. Installations will vary.

ADA compliant when installed to the specific requirements of these regulations.